

HLA 135, 135 K

STIHL



2 - 24

Instruction Manual



Contents

| | | |
|----|--|----|
| 1 | Introduction..... | 2 |
| 2 | Guide to Using this Manual..... | 2 |
| 3 | Overview..... | 3 |
| 4 | Safety Precautions..... | 5 |
| 5 | Preparing Hedge Trimmer for Operation.. | 10 |
| 6 | Charging the Battery, LEDs..... | 10 |
| 7 | Activating and Deactivating Bluetooth® Radio Interface..... | 11 |
| 8 | Assembling the Hedge Trimmer..... | 11 |
| 9 | Removing and Fitting the Battery..... | 12 |
| 10 | Switching the Hedge Trimmer On/Off..... | 12 |
| 11 | Testing the Hedge Trimmer and Battery... | 12 |
| 12 | Operating the Hedge Trimmer..... | 13 |
| 13 | After Finishing Work..... | 15 |
| 14 | Transporting..... | 15 |
| 15 | Storing..... | 16 |
| 16 | Cleaning..... | 16 |
| 17 | Maintenance..... | 16 |
| 18 | Repairing..... | 17 |
| 19 | Troubleshooting..... | 17 |
| 20 | Specifications..... | 18 |
| 21 | Combinations of Carrying Systems..... | 20 |
| 22 | Spare Parts and Accessories..... | 20 |
| 23 | Disposal..... | 20 |
| 24 | EC Declaration of Conformity..... | 21 |
| 25 | UKCA Declaration of Conformity..... | 21 |
| 26 | General Power Tool Safety Warnings..... | 22 |

1 Introduction

Dear Customer,

Thank you for choosing STIHL. We develop and manufacture our quality products to meet our customers' requirements. The products are designed for reliability even under extreme conditions.

STIHL also stands for premium service quality. Our dealers guarantee competent advice and instruction as well as comprehensive service support.

STIHL expressly commit themselves to a sustainable and responsible handling of natural resources. This user manual is intended to help you use your STIHL product safely and in an environmentally friendly manner over a long service life.

We thank you for your confidence in us and hope you will enjoy working with your STIHL product.



Dr. Nikolas Stihl

IMPORTANT! READ BEFORE USING AND KEEP IN A SAFE PLACE FOR REFERENCE.

2 Guide to Using this Manual

2.1 Applicable documents

The local safety regulations apply.

- ▶ In addition to this User Manual, you should also read, understand and retain the following documents:
 - User manual of the carrying system you are using
 - User Manual for STIHL AR battery
 - User Manual for "AP belt bag with connecting cable"
 - Safety notices and precautions for STIHL AP battery
 - User Manual for STIHL AL 101, 301, 301-4, 500 chargers
 - Safety information for STIHL batteries and products with built-in battery:
www.stihl.com/safety-data-sheets

For further information on STIHL connected, compatible products and FAQs, please visit www.connect.stihl.com or available from a STIHL servicing dealer.

The Bluetooth® word mark and logos are registered trademarks owned by Bluetooth SIG, Inc. These word marks and logos are used by STIHL under license.

Batteries with  are equipped with a Bluetooth® radio interface. Local operating restrictions (in aircraft or hospitals, for example) must be observed.

2.2 Warning Notices in Text

DANGER

- This notice refers to risks which result in serious or fatal injury.
 - ▶ Serious or fatal injuries can be avoided by taking the precautions mentioned.

WARNING

- This notice refers to risks which **can** result in serious or fatal injury.
 - ▶ Serious or fatal injuries can be avoided by taking the precautions mentioned.

NOTICE

- This notice refers to risks which can result in damage to property.
 - ▶ Damage to property can be avoided by taking the precautions mentioned.

2.3 Symbols in Text

This symbol refers to a chapter in this instruction manual.

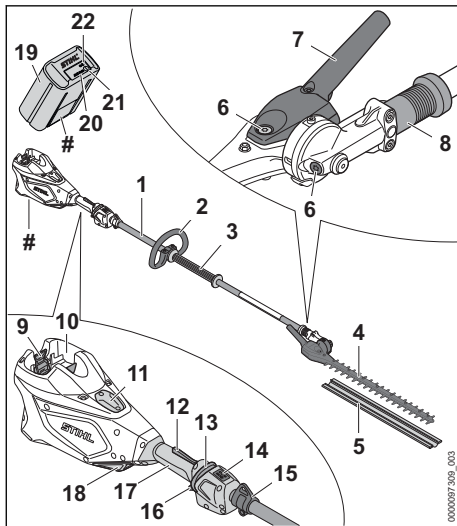
3 Overview**3.1 STIHL HLA 135 Gasoline extended Hedge Trimmer and battery****1 Shaft**

The shaft connects all components.

2 Loop handle

For holding and controlling the long-reach hedge trimmer.

3 Handle hose

For holding and controlling the long-reach hedge trimmer.

4 Cutting blades

The cutting blades cut the material to be trimmed.

5 Blade scabbard

The blade scabbard protects against contact with the cutting blades.

6 Screw plug

The screw plug closes the filler opening for STIHL gear grease.

7 Swivel handle

Serves to adjust angle of cutting blades.

8 Sliding sleeve

Unlocks the blade angle adjuster.

9 Locking lever

The locking lever holds the battery in the battery compartment.

10 Battery compartment

The battery compartment holds the battery.

11 Cover¹

The cover is the placeholder for a Smart Connector 2 A.

12 Trigger lockout

The trigger lockout unlocks the trigger.

13 Release slide

The release slide is used to switch on the long-reach hedge trimmer.

14 LED

These LEDs indicate the selected power level.

15 Carrying ring

The carrying ring is for attaching the carrying system.

16 Trigger

Switches the long-reach hedge trimmer on and off.

17 Control handle

For operating, holding and controlling the long-reach hedge trimmer.

18 Air filter

The air filter filters the air entering the engine.

19 Battery

Supplies power to the long-reach hedge trimmer.

20 LEDs

The LEDs indicate the state of charge of the battery and any faults.

¹The cover is part of the motor housing. Only remove the cover to install a Smart Connector 2 A and store it safely for later re-installation. Always use the long-reach hedge trimmer with the cover or Smart Connector 2 A installed.

21 Pushbutton

The pushbutton activates the LEDs on the battery. The pushbutton activates and deactivates Bluetooth® radio interface (if available).

22 "BLUETOOTH®" LED (only for batteries with)

The LED indicates the activation and deactivation of the Bluetooth® interface.

Rating plate with the machine number

3.2 STIHL HLA 135 K long-reach hedge trimmer and battery

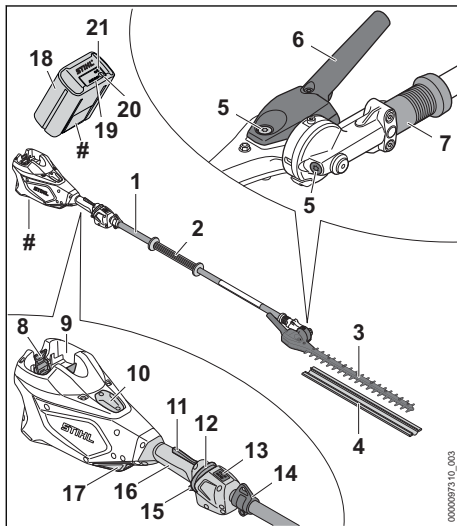

1 Shaft

The shaft connects all components.

2 Handle hose

For holding and controlling the long-reach hedge trimmer.

3 Cutting blades

The cutting blades cut the material to be trimmed.

4 Blade scabbard

The blade scabbard protects against contact with the cutting blades.

5 Screw plug

The screw plug closes the filler opening for STIHL gear grease.

6 Swivel handle

Serves to adjust angle of cutting blades.

7 Sliding sleeve

Unlocks the blade angle adjuster.

8 Locking lever

The locking lever holds the battery in the battery compartment.

9 Battery compartment

The battery compartment holds the battery.

10 Cover²

The cover is the placeholder for a Smart Connector 2 A.

11 Trigger lockout

The trigger lockout unlocks the trigger.

12 Release slide

The release slide is used to switch on the long-reach hedge trimmer.

13 LED

These LEDs indicate the selected power level.

14 Carrying ring

The carrying ring is for attaching the carrying system.

15 Trigger

Switches the long-reach hedge trimmer on and off.

16 Control handle

For operating, holding and controlling the long-reach hedge trimmer.

17 Air filter

The air filter filters the air entering the engine.

18 Battery

Supplies power to the long-reach hedge trimmer.

19 LEDs

The LEDs indicate the state of charge of the battery and any faults.

20 Pushbutton

The pushbutton activates the LEDs on the battery. The pushbutton activates and deactivates Bluetooth® radio interface (if available).

21 "BLUETOOTH®" LED (only for batteries with)

The LED indicates the activation and deactivation of the Bluetooth® interface.

²The cover is part of the motor housing. Only remove the cover to install a Smart Connector 2 A and store it safely for later re-installation. Always use the long-reach hedge trimmer with the cover or Smart Connector 2 A installed.

Rating plate with the machine number

3.3 Symbols

The symbols which may be on the long-reach hedge trimmer and battery have the following meanings:



The clamp nut is unscrewed in this position. The shaft can be extended.



The clamp nut is locked in this position. The shaft cannot be extended.



This icon marks the release slide.



1 LED lights up red. The battery is too warm or too cold.



4 LEDs flash red. There is a fault in the battery.



Guaranteed sound power level in accordance with Directive 2000/14/EC in dB(A) for the purpose of comparing the sound emissions of products.



The battery is equipped with a Bluetooth® radio interface and can be paired with the STIHL connected app.



The information next to the symbol indicates the energy content of the battery according to the cell manufacturer's specification. The energy content available in operation is lower.



Do not dispose of the product with domestic waste.

4 Safety Precautions

4.1 Warning symbols

Meanings of warning signs and labels on the long-reach hedge trimmer or battery:



Observe safety warnings and take the necessary precautions.



Read and understand the User Manual and keep it in a safe place for reference.



Wear safety glasses and a hard hat.



Wear safety boots.



Wear work gloves.



Do not touch moving cutting blades.

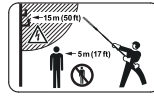

Maintain a safe distance.



Remove the battery during work interruptions, transport, storage, maintenance or repair.



Protect the battery against heat and fire.



Do not immerse the battery in liquids.



Do not touch a hot surface.

4.2 Intended Use

The STIHL HLA 135 long-reach hedge trimmer is used to cut low growing shrubs, tall hedges, tall shrubs, tall bushes and tall thickets.

The STIHL HLA 135 K long-reach hedge trimmer is used to cut low growing shrubs, tall hedges, tall shrubs, tall bushes and tall thickets.

The long-reach hedge trimmer may be used in the rain.

The long-reach hedge trimmer is powered by a STIHL AP battery or a STIHL AR battery.

The battery with  in combination with the STIHL connected app enables customization and the transfer of information to the battery using Bluetooth® technology.

WARNING

- Batteries not explicitly approved for the long-reach hedge trimmer by STIHL may cause fire or explosion. Persons may be seriously or fatally injured, and property may be damaged.
 - ▶ Use the long-reach hedge trimmer with a STIHL AP battery or a STIHL AR battery.
- Using the long-reach hedge trimmer or the battery for purposes for which they were not

designed may result in serious or fatal injuries and damage to property.

- ▶ Use the long-reach hedge trimmer as described in this User Manual.
- ▶ Use the battery as described in this User Manual, the STIHL AR battery User Manual, the STIHL connected app and at www.connect.stihl.com.

4.3 The Operator

▲ WARNING

- Users without adequate training or instruction cannot recognize or assess the risks involved in using the hedge trimmer and battery. The user or other persons may sustain serious or fatal injuries.



- ▶ Read, understand and save the instruction manual.

- ▶ If the hedge trimmer or battery is passed on to another person: Always give them the instruction manual.
- ▶ Make sure the user meets the following requirements:
 - The user must be rested.
 - The user must be in good physical condition and mental health to operate and work with the hedge trimmer and battery. If the user's physical, sensory or mental ability is restricted, he or she may work only under the supervision of or as instructed by a responsible person.
 - The user is able to recognize and assess the risks involved in using the hedge trimmer and battery.
 - The user must be of legal age or is being trained in a trade under supervision in accordance with national rules and regulations.
 - The user has received instruction from a STIHL servicing dealer or other experienced user before working with the hedge trimmer for the first time.
 - The user must not be under the influence of alcohol, medication or drugs.
- ▶ If you have any queries: Contact a STIHL servicing dealer for assistance.

4.4 Clothing and equipment

▲ WARNING

- Long hair may be pulled into the long-reach hedge trimmer during operation. This may result in serious injury to the user.
 - ▶ Tie up and confine long hair above your shoulders.
- Objects can be thrown at high speed during operation. This may result in injury to the user.



- ▶ Wear close-fitting safety glasses. Suitable safety glasses are tested in accordance with EN 166 or national regulations and available commercially with the corresponding marking.

- Falling objects can cause head injuries.



- ▶ wear a hard hat.

- Dust can be whipped up during operation. Whipped up dust can damage the respiratory passages and cause allergic reactions.

- ▶ If dust is generated: Wear a dust respirator mask.

- Unsuitable clothing may snag on wood, thickets or the long-reach hedge trimmer. Users not wearing suitable clothing are at risk of serious injury.

- ▶ Wear close-fitting clothing.
- ▶ Remove scarves and jewelry.
- The user may come into contact with the cutting blades during cleaning or servicing. This may result in injury to the user.
- ▶ Wear work gloves made from resistant material.



- Wearing unsuitable footwear may cause the user to slip. This may result in injury to the user.



- ▶ Wear sturdy, closed-toed footwear with high-grip soles.

4.5 Work Area and Surroundings

4.5.1 Long-reach hedge trimmer

▲ WARNING

- Bystanders, children and animals cannot recognize or assess the dangers of the long-reach hedge trimmer or flying debris. This may result in serious injury to bystanders, children and animals and damage to property.

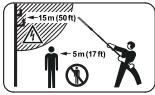

- ▶ Do not allow bystanders, children or animals within 5 meters of the work area.

- ▶ Maintain a clearance of 5 meters from objects.
- ▶ Do not leave the long-reach hedge trimmer unattended.
- ▶ Ensure that children cannot play with the long-reach hedge trimmer.
- Electrical components of the long-reach hedge trimmer can generate sparks. Sparks may cause fires and explosions in highly flammable or explosive environments. Persons may be seriously or fatally injured and property may be damaged.
 - ▶ Do not work in a highly flammable or explosive environment.

4.5.2 Battery

⚠ WARNING

- Bystanders, children and animals cannot recognize or assess the dangers of the battery. Bystanders, children and animals may be seriously injured.
 - ▶ Keep bystanders, children and animals away from the work area.
 - ▶ Do not leave the battery unattended.
 - ▶ Make sure that children cannot play with the battery.
- The battery is not protected against all ambient conditions. If the battery is exposed to certain ambient conditions, the battery may catch fire, explode or be irreparably damaged. This may result in serious injury to people and damage to property.



- ▶ Protect battery from heat and fire.
- ▶ Do not throw the battery into a fire.

- ▶ Do not charge, use and store the battery outside of the specified temperature limits, **20.4**.



- ▶ Do not immerse the battery in liquids.

- ▶ Keep battery away from small metal parts.
- ▶ Do not expose the battery to high pressure.
- ▶ Do not expose the battery to microwaves.
- ▶ Protect the battery from chemicals and salts.

4.6 Safe Condition

4.6.1 Long-reach hedge trimmer

The long-reach hedge trimmer is in a safe condition if the following points are observed:

- The long-reach hedge trimmer is not damaged.
- The long-reach hedge trimmer is clean.
- The controls function properly and have not been modified.
- The cutting blades are correctly fitted.
- Only original STIHL accessories designed for this long-reach hedge trimmer are fitted.
- The accessories are correctly attached.

⚠ WARNING

- If not in safe condition, components may no longer operate correctly and safety devices may be disabled. This may result in serious or fatal injury to people.
 - ▶ Work only with an undamaged long-reach hedge trimmer.
 - ▶ If the long-reach hedge trimmer is dirty: Clean the long-reach hedge trimmer.
 - ▶ Do not modify the long-reach hedge trimmer.
 - ▶ If the controls do not function properly: Do not work with the long-reach hedge trimmer.
 - ▶ Only fit original STIHL accessories designed for this long-reach hedge trimmer.
 - ▶ Attach accessories as described in this User Manual or in the User Manual for the accessories.
 - ▶ Never insert objects into the openings of the long-reach hedge trimmer.
 - ▶ Replace worn or damaged labels.
 - ▶ If you have any doubts, be sure to consult a STIHL dealer.

4.6.2 Cutting Blades

The cutting blades are in a safe condition if the following points are observed:

- Cutting blades are undamaged.
- Cutting blades are not deformed.
- Cutting blades move freely.
- Cutting blades are properly sharpened.
- Cutting blades have no burrs.

⚠ WARNING

- If they are in an unsafe condition, parts of the cutting blades may come off and be thrown at high speed. This can result in serious injuries.
 - ▶ Work only with undamaged cutting blades.
 - ▶ Make sure the cutting blades are properly sharpened and deburred.

- ▶ If you have any queries: Contact your STIHL servicing dealer.

4.6.3 Battery

The battery is in a safe condition if the following points are observed:

- Battery is undamaged.
- The battery is clean and dry.
- Battery functions properly and has not been modified.

⚠ WARNING

- A battery that is not in a safe condition cannot operate safely. Persons may be seriously injured.
 - ▶ Never work with a damaged battery.
 - ▶ Never attempt to charge a damaged or defective battery.
 - ▶ If the battery is dirty: Clean the battery.
 - ▶ If the battery is wet or damp: Allow the battery to dry,  20.5.
 - ▶ Never attempt to modify the battery.
 - ▶ Never insert objects in the battery's openings.
 - ▶ Never bridge the battery's contacts with metallic objects (short circuit).
 - ▶ Do not open the battery.
 - ▶ Replace worn or damaged labels.
- Fluid may leak from a damaged battery. If that liquid comes into contact with the skin or eyes, the skin or eyes may be irritated.
 - ▶ Avoid contact with the liquid.
 - ▶ If skin contact occurs: Wash affected areas of skin with plenty of water and soap.
 - ▶ In the event of contact with eyes: Rinse eyes with plenty of water for at least 15 minutes and consult a doctor.
- A damaged or defective battery may smell unusual, emit smoke or burn. Persons may be seriously or fatally injured, and property may be damaged.
 - ▶ If the battery smells unusual or emits smoke: do not use the battery and keep it away from combustible substances.
 - ▶ If the battery catches fire: Attempt to extinguish the battery with a fire extinguisher or water.

4.7 Working

⚠ WARNING

- In certain situations, the user may no longer be able to concentrate on their work. This may result in the user stumbling, falling and suffering serious injury.
 - ▶ Keep calm and plan your work.

- ▶ If light and visibility are poor: Do not work with the long-reach hedge trimmer.
- ▶ Operate the long-reach hedge trimmer alone.
- ▶ Watch out for obstacles.
- ▶ Work standing on the ground and keep your balance. If you have to work at a height: Use a mobile elevating work platform or secure scaffolding.
- ▶ If you start feeling fatigue: Take a break.
- Working above shoulder height can cause fatigue sooner. This may result in serious injury to the user.
 - ▶ Work above shoulder height for short periods only.
 - ▶ Take breaks.
- If the moving cutting blade makes contact with a hard object it can be brought to a sudden stop. The reactive forces that occur can cause the user to lose control of the long-reach hedge trimmer and be seriously injured.
 - ▶ Hold the long-reach hedge trimmer firmly with both hands.
 - ▶ Before starting work, check hedge for hard objects and remove any such objects.
- The moving cutting blades can cut the user. This may result in serious injury to the user.
 - ▶ Do not touch moving cutting blades.
 - ▶ If the cutting blades are blocked by an object: Switch off the long-reach hedge trimmer and remove the battery. before clearing the jam.
- If the behavior of the long-reach hedge trimmer changes during operation or feels unusual, it may no longer be in a safe condition. This may result in serious injury to people and damage to property.
 - ▶ Stop working, remove the battery and consult a STIHL dealer.
- Vibrations may occur while using the long-reach hedge trimmer.
 - ▶ Wear gloves.



- ▶ Take breaks.
- ▶ If signs of a circulatory disturbance occur: Consult a doctor.
- Note that the cutting blades continue to run for a short period after you release the trigger. The moving cutting blades may cut the user. They may cause serious injury to persons.
 - ▶ Wait until the cutting blades come to a complete standstill.

- In an emergency, the user may start to panic and forget to take off the carrying system. This may result in serious injury to the user.
 - ▶ Practice taking off the carrying system.

⚠ DANGER

- Working near live electric cables may result in accidental contact with and damage to the cutting blades. This may result in serious or fatal injury to the user.



- ▶ Maintain a clearance of 15 meters from live cables.

4.8 Transporting

4.8.1 Hedge Trimmer

⚠ WARNING

- The hedge trimmer may turn over or shift during transport. This may result in personal injuries and damage to property.



- ▶ Remove the battery.

- ▶ Fit the blade scabbard so that it completely covers the cutting blades.
- ▶ Secure the hedge trimmer with lashing straps or a net to prevent it turning over and moving.

4.8.2 Battery

⚠ WARNING

- The battery is not protected against all ambient conditions. The battery may be damaged if it is exposed to certain ambient conditions, and damage to property may occur.
 - ▶ Never transport a damaged battery.
- The battery may turn over or shift during transport. This may result in injury to people and damage to property.
 - ▶ Pack the battery in packaging in such a way that it cannot move.
 - ▶ Secure the packaging so that it cannot move.

4.9 Storing

4.9.1 Long-reach hedge trimmer

⚠ WARNING

- Children are not aware of and cannot assess the dangers of the long-reach hedge trimmer. Children may be seriously injured.



- ▶ Remove the battery.

- ▶ Push the blade scabbard over the cutting blades, ensuring that it completely covers the cutting blades.
- ▶ Store the long-reach hedge trimmer out of the reach of children.
- Dampness can corrode the electrical contacts on the long-reach hedge trimmer and metal components. The long-reach hedge trimmer may be damaged.



- ▶ Remove the battery.

- ▶ Store the long-reach hedge trimmer in a clean and dry condition.

4.9.2 Battery

⚠ WARNING

- Children are not aware of and cannot assess the dangers of the battery. Children may be seriously injured.
 - ▶ Store the battery out of the reach of children.
- The battery is not protected against all ambient conditions. If the battery is exposed to certain ambient conditions, the battery may be irreparably damaged.
 - ▶ Store the battery in a clean and dry condition.
 - ▶ Store the battery in an enclosed space.
 - ▶ Store the battery separately from the hedge trimmer.
 - ▶ If the battery is stored in the charger, disconnect the mains plug and store the battery at a state of charge between 40% and 60% (2 lit green LEDs).
 - ▶ Do not store the battery outside of the specified temperature limits, 20.4.

4.10 Cleaning, Maintenance and Repair

⚠ WARNING

- The long-reach hedge trimmer may start unintentionally if the battery is left in place during cleaning, maintenance or repair operations. This may result in serious injury to people and damage to property.



- ▶ Remove the battery.

- The gear housing can get hot during operation. There is a risk of burn injuries.



- ▶ Do not touch a hot gear housing.

- Aggressive cleaning agents, a water jet or pointed objects can damage the long-reach hedge trimmer, cutting blades and the battery. If the long-reach hedge trimmer, cutting blades or battery are not cleaned correctly, components may no longer function properly or safety devices may be rendered inoperative. They may cause serious injury to persons.

- ▶ Clean the long-reach hedge trimmer, cutting blades and battery as described in this User Manual.
- If the long-reach hedge trimmer, cutting blades or battery are not serviced or repaired correctly, components may no longer function properly or safety devices may be rendered inoperative. This may result in serious or fatal injury to people.
 - ▶ Do not attempt to service or repair the long-reach hedge trimmer or battery.
 - ▶ If the long-reach hedge trimmer or the battery require servicing or repairs: Contact your STIHL dealer for assistance.
 - ▶ Maintain the cutting blades as described in this User Manual.

- The user may be cut while cleaning or servicing the sharp cutting blades. This may result in injury to the user.



- ▶ Wear work gloves made from resistant material.

5 Preparing Hedge Trimmer for Operation

5.1 Preparing the Long-Reach Hedge Trimmer for Operation

The following steps must be performed before commencing work:

- ▶ Ensure that the following components are in a safe condition:
 - Long-reach hedge trimmer, 4.6.1.
 - Cutting blades, 4.6.2.
 - Battery, 4.6.3.
- ▶ Check the battery, 11.2.

- ▶ Fully charge battery as described in the User Manual for the STIHL AL 101, 301, 301-4, 500 chargers.
- ▶ Clean the long-reach hedge trimmer, 16.1.
- ▶ Assembling the long-reach hedge trimmer, 8.1.
- ▶ Mount the loop handle (HLA 135), 8.2.
- ▶ Adjust the angle of the cutting blades, 12.1.
- ▶ Fit and adjust the shoulder strap, 12.2.
- ▶ Check the controls, 11.1.
- ▶ If you cannot carry out these steps: Do not use the long-reach hedge trimmer and contact your STIHL authorized dealer for assistance.

5.2 Connecting a battery with Bluetooth® radio interface with the STIHL connected app

- ▶ Activate the Bluetooth® radio interface on the mobile device.
- ▶ Activating the Bluetooth® radio interface on the battery, 7.1.
- ▶ Download the STIHL connected app to the mobile device from the App Store and create an account.
- ▶ Open and sign in to the STIHL connected app.
- ▶ Add the battery in the STIHL connected app and follow the instructions on the screen.

For contacts and other information, please visit <https://support.stihl.com> or see the STIHL connected app.

The STIHL connected app is available internationally.

6 Charging the Battery, LEDs

6.1 Charging the Battery

The charging time depends on various factors, e.g. the battery temperature or the ambient temperature. For optimum performance, observe the recommended temperature ranges, 20.5. The actual charging time may vary from the charging time indicated. The charging time is indicated at www.stihl.com/charging-times.

- ▶ Recharge the battery as described in the User Manual for the STIHL AL 101, 301, 301-4, 500 chargers.

6.2 Displaying the charge level

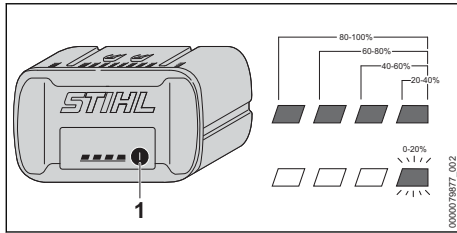

- ▶ Press the button (1).
The LEDs light up green for about 5 seconds and indicate the state of charge.
- ▶ If the LED on the right flashes green: Charge the battery.

6.3 LEDs on Battery

The LEDs can show the state of charge or malfunctions. The LEDs can glow or flash green or red.

The state of charge is indicated when the LEDs glow or flash green.

- ▶ If the LEDs glow or flash red: Troubleshooting, 19.
There is a malfunction in hedge trimmer or battery.

7 Activating and Deactivating Bluetooth® Radio Interface

7.1 Activating the Bluetooth® Radio Interface

- ▶ If the battery has a Bluetooth® radio interface: Press and hold the pushbutton until the "BLUETOOTH®" LED next to the symbol lights up blue for approximately 3 seconds.
The Bluetooth® radio interface on the battery is activated.

7.2 Deactivating the Bluetooth® Radio Interface

- ▶ If the battery has a Bluetooth® radio interface: Press and hold the pushbutton until the "BLUETOOTH®" LED next to the symbol lights up blue six times.
The Bluetooth® radio interface on the battery is deactivated.

8 Assembling the Hedge Trimmer

8.1 Assembling the Long-Reach Hedge Trimmer

- ▶ Switch off the long-reach hedge trimmer and remove the battery.

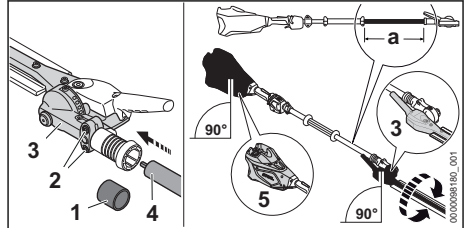

- ▶ Remove the protective cap (1).
- ▶ Undo the screws (2).
- ▶ Push the transmission (3) onto the shaft (4) in such a way that the following conditions are met:
 - In case of assembly of an HLA 135: a = approx. 53 cm
 - In case of assembly of an HLA 135 K: a = approx. 38 cm
- ▶ Align the housing (5) and transmission (3) as shown.
- ▶ Tighten down the screws (2) firmly.

The long-reach hedge trimmer does not need to be dismantled again.

8.2 Mounting the Loop Handle (HLA 135)

- ▶ Switch off the long-reach hedge trimmer and remove the battery.

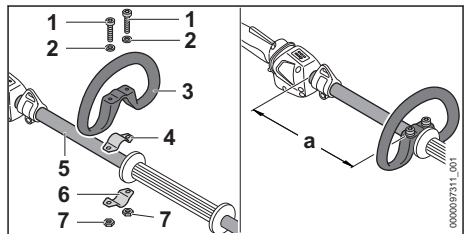

- ▶ Fit the clamp (4) in the loop handle (3).
- ▶ Place the loop handle (3) with clamp (4) on the shaft (5).
- ▶ Fit the washers (2) on the screws (1).
- ▶ Press the clamp (4) against the shaft (5).
- ▶ Insert the screws (1) through holes in the loop handle (3) and clamps (4 and 6).
- ▶ Slide the loop handle (3) until the distance (a) is 20 cm.

- ▶ Screw on and firmly tighten the nuts (7).

9 Removing and Fitting the Battery

9.1 Inserting the Battery

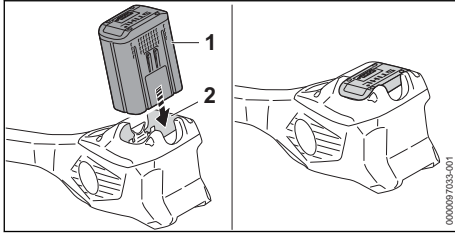

- ▶ Insert the battery (1) up to the limit stop into the battery compartment (2). The battery (1) engages with a click and is now locked.

9.2 Removing the Battery

- ▶ Stand the hedge trimmer on a level surface.

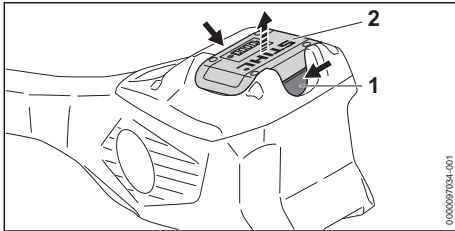

- ▶ Press both locking levers (1). The battery (2) is released and can be removed.

10 Switching the Hedge Trimmer On/Off

10.1 Switching on the long-reach hedge trimmer

- ▶ Hold the long-reach hedge trimmer with one hand on the control handle - wrap your thumb around the handle.
- ▶ Hold the long-reach hedge trimmer firmly with your other hand on the loop handle or handle hose - wrap your thumb around the loop handle or handle hose.

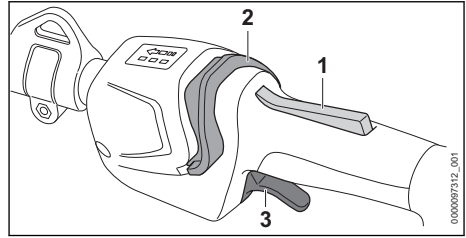

- ▶ Press the trigger lockout (1) with your hand and keep it pressed.
- ▶ Push the release slide (2) in the direction of the loop handle with your thumb and hold it there. The LEDs emit light to indicate the power level used last.
- ▶ Press the trigger (3) with your index finger and keep depressed. The long-reach hedge trimmer accelerates and the cutting blades run.

The long-reach hedge trimmer can also be switched on by first pressing the release slide (2) and pressing the trigger lockout (1) within 5 seconds (as long as the LEDs are flashing). The trigger (3) is now unlocked and the long-reach hedge trimmer is ready for use.

The LEDs continue flashing for 5 seconds after the trigger (3) and trigger lockout (1) are released after switch-on. As long as the LEDs flash, the long-reach hedge trimmer can be switched on again without having to actuate the release slide (2).

10.2 Switching off long-reach hedge trimmer

- ▶ Release the trigger and trigger lockout.
- ▶ Wait until the cutting blades come to a complete standstill.
- ▶ If the cutting blades continue to run: Remove the battery and contact your STIHL dealer for assistance. There is a malfunction in the long-reach hedge trimmer.

11 Testing the Hedge Trimmer and Battery

11.1 Checking the controls

Trigger lockout and trigger

- ▶ Remove the battery.
- ▶ Try pressing the trigger without pressing the trigger lockout.

- ▶ If the trigger can be pulled: Do not use the long-reach hedge trimmer and contact your STIHL dealer for assistance. The trigger lockout is faulty.
- ▶ Press and hold the trigger lockout.
- ▶ Squeeze and release the trigger.
- ▶ If the trigger or trigger lockout is stiff or does not spring back to the idle position: Do not use your long-reach hedge trimmer and contact your STIHL dealer. The trigger or the trigger lockout is defective.

Switching on the long-reach hedge trimmer

- ▶ Insert battery.
- ▶ Press and hold the trigger lockout.
- ▶ Push the release slide in the direction of the cutting blades with your thumb.
- ▶ Press and hold the trigger. The cutting blades run.
- ▶ If 3 LEDs flash red: Remove the battery and consult a STIHL dealer. There is a malfunction in the long-reach hedge trimmer.
- ▶ Release the trigger. The cutting blades come to a complete standstill.
- ▶ If the cutting blades continue to run: Remove the battery and contact your STIHL dealer for assistance. There is a malfunction in the long-reach hedge trimmer.

11.2 Testing the Battery

- ▶ Press button on battery. The LEDs glow or flash.
- ▶ If the LEDs do not glow or flash: Do not use the battery and contact your STIHL servicing dealer. There is a malfunction in the battery.

12 Operating the Hedge Trimmer

12.1 Adjusting the Angle of the Cutting Blades

The angle of the cutting blades can be adjusted to 4 different positions upwards and 7 different positions downwards to suit the application and the height and reach of the user.

- ▶ Switch off the long-reach hedge trimmer and remove the battery.

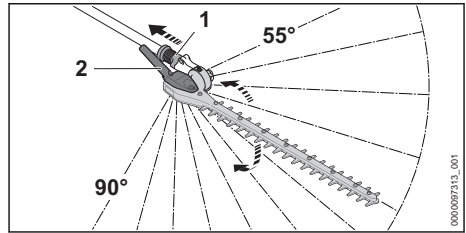

- ▶ Pull back the sliding sleeve (1) and hold it there.
- ▶ Grip the swivel handle (2) and swing cutting blade to required angle.
- ▶ Release the sliding sleeve (1).
- ▶ Move swivel handle (2) back and forth until the sliding sleeve (1) engages. The sliding sleeve (1) butts against the housing. You have adjusted the angle of the cutting blades.
- ▶ Check that the swivel handle (2) cannot be pushed in or pulled out any more.

12.2 Fitting and Adjusting the Shoulder Strap

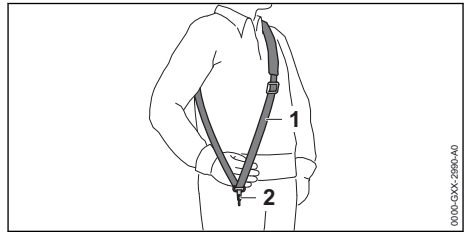

- ▶ Put on the shoulder strap (1).
- ▶ Adjust the shoulder strap (1) so that the carabiner (2) is about a hand's width below your right hip.

Other approved carrying systems are listed in this User Manual, [21](#).

12.3 Holding and controlling the long-reach hedge trimmer

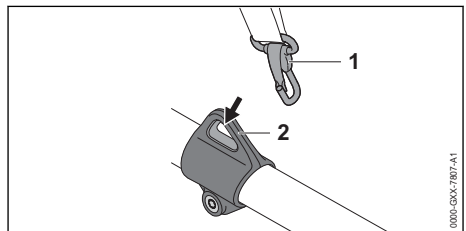

- ▶ Connect the carrying ring (2) to the carabiner (1).

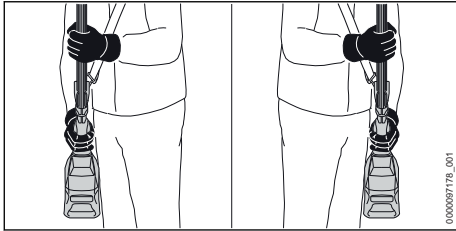

- ▶ Hold the long-reach hedge trimmer with one hand on the control handle and clasp the control handle with your thumb.
- ▶ Hold the long-reach hedge trimmer firmly with your other hand on the handle hose and clasp the handle hose with your thumb.

HLA 135

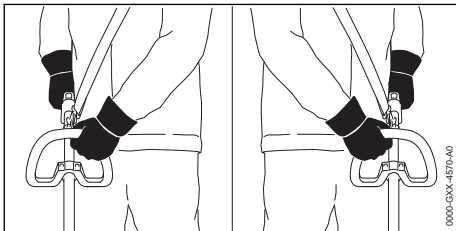

- ▶ Hold the long-reach hedge trimmer with one hand on the control handle and clasp the control handle with your thumb.
- ▶ Hold the long-reach hedge trimmer with your other hand on the loop handle and clasp the loop handle with your thumb.

12.4 Setting the performance level

Depending on the application, 3 power levels can be set. The LEDs indicate the selected power level. The higher the power level, the faster the cutting blades can run.

The selected power level affects the battery's runtime. The lower the power level, the longer the runtime.

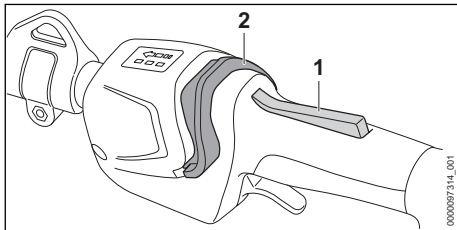

- ▶ Press and hold the trigger lockout (1).
- ▶ Push the release slide (2) in the direction of the cutting blades with your thumb.

The LEDs emit light to indicate the power level selected.

- ▶ Push the release slide (2) forwards, hold it briefly in that position and allow it to spring back. This selects the next power level. After the third performance level, it starts again with the first performance level.
- ▶ Push the release slide (2) forwards and allow it to spring back as many times as necessary to select the required power level.

12.5 Cutting

Cutting close to the ground (HLA 135)

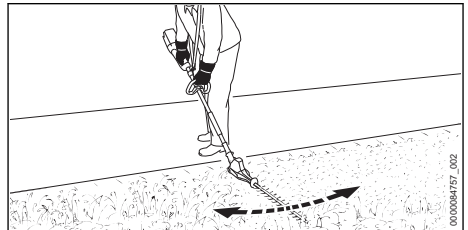

- ▶ Set the cutting blades to a suitable angle.
- ▶ Swing the long-reach hedge trimmer evenly back and forth in an arc.
- ▶ Walk forward slowly and steadily.
- ▶ If cutting performance deteriorates: Sharpen the cutting blades.

Cutting the side of the hedge

- ▶ Use pruning shears or a chainsaw to cut out thick branches first.

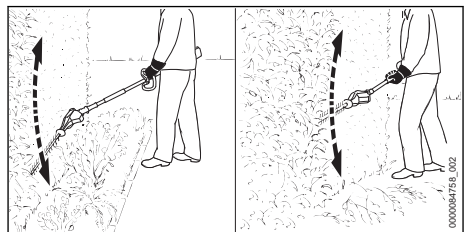

- ▶ If you have to cut at a certain distance from the hedge: Set the cutting blades to a suitable angle.
- ▶ Swing the long-reach hedge trimmer in an arc at one side of the hedge while making the cut.
- ▶ Walk forward slowly and steadily.
- ▶ Cut the other side of the hedge in the same way.
- ▶ If cutting performance deteriorates: Sharpen the cutting blades.

Cutting the top of the hedge

- ▶ Use pruning shears or a chainsaw to cut out thick branches first.

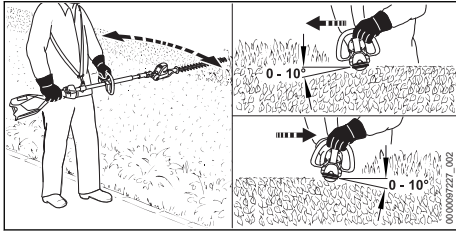

- ▶ Hold the cutting blades at an angle of 0° to 10° to the top of the hedge.
- ▶ Swing the long-reach hedge trimmer horizontally and in an arc while making the cut.
- ▶ If cutting performance deteriorates: Sharpen the cutting blades.

Cutting overhead

- ▶ Use pruning shears or a chainsaw to cut out thick branches first.

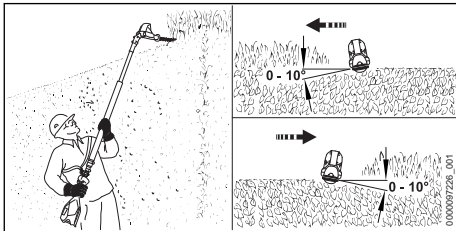

- ▶ Set the cutting blades completely to a suitable angle.
- ▶ Hold the cutting blades at an angle of 0° to 10° to the top of the hedge.
- ▶ Swing the long-reach hedge trimmer horizontally and in an arc while making the cut.
- ▶ If cutting performance deteriorates: Sharpen the cutting blades.

For optimum performance, observe the recommended temperature ranges, 20.5.

13 After Finishing Work

13.1 After Finishing Work

- ▶ Switch off the hedge trimmer and remove the battery.
- ▶ If the gasoline extended hedge trimmer is wet: Allow it to dry.
- ▶ If the battery is moist or wet: Allow the battery to dry, 20.5.
- ▶ Clean the gasoline extended hedge trimmer.
- ▶ Clean the cutting blades.

- ▶ Fit the blade scabbard so that it completely covers the cutting blades.
- ▶ Clean the battery.

14 Transporting

14.1 Transporting the long-reach hedge trimmer

- ▶ Switch off the long-reach hedge trimmer and remove the battery.
- ▶ Push the blade scabbard over the cutting blades, ensuring that it completely covers the cutting blades.

Carrying the long-reach hedge trimmer

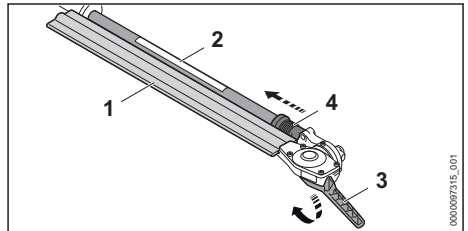

- ▶ Pull back and hold the sliding sleeve (4).
- ▶ Grip the swivel handle (3) and fold down the cutting blades (1). The cutting blades (1) are parallel to the shaft (2).
- ▶ Release the sliding sleeve (4). The sliding sleeve (4) engages and is positioned on the housing. The cutting blades (1) are in the transport position.
- ▶ Carry the long-reach hedge trimmer with one hand on the shaft, ensuring that the cutting blades (1) are pointing to the rear.

Transporting the long-reach hedge trimmer in a vehicle

- ▶ Secure the hedge trimmer so that it cannot turn over or move.

14.2 Transporting the Battery

- ▶ Switch off the hedge trimmer and remove the battery.
- ▶ Check that the battery is in a safe condition.
- ▶ Pack the battery in packaging in such a way that it cannot move inside the packaging.
- ▶ Secure the packaging so that it cannot move.

The battery is subject to the Carriage of Dangerous Goods regulations. The battery is classified as UN 3480 (lithium ion batteries) and has been tested pursuant to UN Manual Tests and Criteria Part III, Subsection 38.3.

The transport regulations can be found at www.stihl.com/safety-data-sheets.

15 Storing

15.1 Storing the Hedge Trimmer

- ▶ Switch off the hedge trimmer and remove the battery.
- ▶ Fit the blade scabbard so that it completely covers the cutting blades.
- ▶ Observe the following points when storing the hedge trimmer:
 - Hedge trimmer is out of the reach of children.
 - Hedge trimmer is clean and dry.

15.2 Storing the Battery

STIHL recommends keeping the battery in a charging state between 40% and 60 % (2 green LEDs lit).

- ▶ The battery should be stored in such a way that the following conditions are fulfilled:
 - The battery is out of the reach of children.
 - The battery is clean and dry.
 - The battery is in an enclosed space.
 - Battery is stored separately from the hedge trimmer.
 - If the battery is stored in the charger, disconnect the mains plug and store the battery at a state of charge between 40% and 60% (2 lit green LEDs).
 - Do not store the battery outside of the specified temperature limits,  20.4.

NOTICE

- If the battery is not stored as described in this User Manual, the battery may become deeply discharged and irreparably damaged.
 - ▶ Charge a discharged battery before storing it. STIHL recommends keeping the battery state of charge between 40% and 60% (2 lit green LEDs).
 - ▶ Store the battery separately from the gas-line extended hedge trimmer.

16 Cleaning

16.1 Cleaning the long-reach hedge trimmer

- ▶ Switch off the long-reach hedge trimmer and remove the battery.
- ▶ Clean the long-reach hedge trimmer with a damp cloth or STIHL resin solvent.
- ▶ Clean vents with a paintbrush.

- ▶ Remove foreign objects from the battery compartment and clean the battery compartment with a damp cloth.
- ▶ Clean the electrical contacts in the battery compartment with a paintbrush or soft brush.

16.2 Cleaning the Cutting Blades

- ▶ Switch off the hedge trimmer and remove the battery.
- ▶ Spray both sides of blades with STIHL resin solvent.
- ▶ Fit the battery.
- ▶ Switch on the hedge trimmer for 5 seconds. The cutting blades run. STIHL resin solvent is distributed evenly.

16.3 Cleaning the Air Filter

- ▶ Switch off the long-reach hedge trimmer and remove the battery.

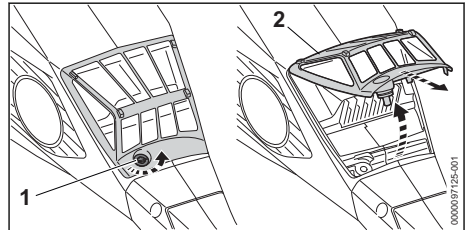

- ▶ Clean the area around the air filter (2) with a damp cloth or a soft brush.
- ▶ Turn the screw (1) counterclockwise until the air filter (2) can be removed.
- ▶ Swing the air filter (2) upwards and pull it off.
- ▶ Pass the air filter (2) under running water to rinse off coarse dirt from the outside.
- ▶ If the air filter (2) is damaged: Install a new air filter (2).
- ▶ Allow the air filter (2) to dry in the air.
- ▶ Install the air filter (2) in the housing and fold it down. The air filter (2) must sit flush in the housing at all sides.
- ▶ Insert and tighten down the screw (1) firmly.

16.4 Cleaning the Battery

- ▶ Clean the battery with a damp cloth.

17 Maintenance

17.1 Maintenance intervals

Maintenance intervals depend on the ambient conditions and the operating conditions. STIHL recommends the following maintenance intervals:

After every 25 hours of operation

- ▶ Lubricate the gearbox.

After every 50 hours of operation

- ▶ Clean the air filter.

Annually

- ▶ Have the long-reach hedge trimmer checked by a STIHL dealer.

17.2 Lubricating the gearbox

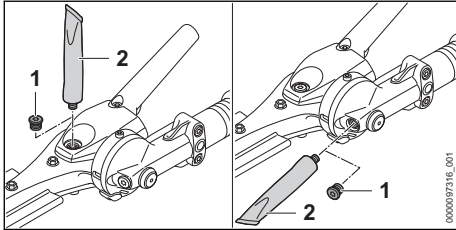

- ▶ Unscrew the screw plugs (1).
- ▶ If no grease is visible at the screw plugs (1):
 - ▶ Screw in the tube of "STIHL Getriebe-fett" (2).
 - ▶ Squeeze 5 g of STIHL gear grease into the gear housing.
 - ▶ Unscrew the tube of "STIHL Getriebe-fett" (2).
 - ▶ Screw in the screw plugs (1) and tighten them.
 - ▶ Switch on the long-reach hedge trimmer for 1 minute.
The STIHL gear grease is distributed evenly.

17.3 Sharpening the cutting blade

STIHL recommends you have the cutting blades resharpened by a STIHL dealer.



WARNING

- The teeth of the cutting blades are very sharp. This may result in the user cutting themselves.
 - ▶ Wear work gloves made from resistant material.

- ▶ Switch off the long-reach hedge trimmer and remove the battery.

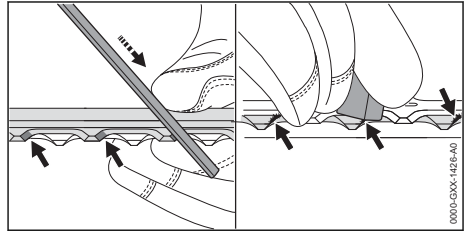

- ▶ Use a STIHL flat file to sharpen each cutting edge on the upper blade. The file only sharpens on the forward stroke. Maintain the prescribed sharpening angle,  20.2.
- ▶ Turn the long-reach hedge trimmer over.
- ▶ Sharpen the remaining cutting edges.
- ▶ Deburr each cutting edge from below.
- ▶ Turn the long-reach hedge trimmer over.
- ▶ Deburr the remaining cutting edges.
- ▶ Use a damp cloth to remove the filing dust.
- ▶ Spray both sides of cutting blades with STIHL resin solvent.
- ▶ Switch on the long-reach hedge trimmer for 5 seconds.
The cutting blades run. STIHL resin solvent is distributed evenly.
- ▶ If you have any doubts, be sure to consult a STIHL dealer.

18 Repairing

18.1 Repairing the Hedge Trimmer and Battery



The hedge trimmer, cutting blades and battery cannot be repaired by the user.

- ▶ If the hedge trimmer or cutting blades are damaged: Do not use your hedge trimmer and contact your STIHL servicing dealer.
- ▶ If the battery has a malfunction or is damaged: Replace the battery.

19 Troubleshooting

19.1 Troubleshooting the gasoline extended hedge trimmer or battery

| Fault | LEDs on the battery | Cause | Remedy |
|--|------------------------|--|--|
| Hedge trimmer does not start when switched on. | 1 LED flashing green. | State of charge of the battery is too low. | ▶ Charge battery as described in the User Manual for chargers STIHL AL 101, 301, 301-4, 500. |
| | 1 LED emits red light. | The battery is too warm or too cold. | ▶ Remove the battery. |

| Fault | LEDs on the battery | Cause | Remedy |
|--|----------------------|--|--|
| | | | <ul style="list-style-type: none"> ▶ Allow the battery to cool down or warm up. |
| | 3 LEDs flashing red. | There is a malfunction in the hedge trimmer. | <ul style="list-style-type: none"> ▶ Remove the battery. ▶ Clean electrical contacts in the battery compartment. ▶ Insert battery. ▶ Switch on the hedge trimmer. ▶ If 3 LEDs continue to flash red: Do not use the hedge trimmer and contact your STIHL dealer for assistance. |
| | | The cutting blades do not run freely. | <ul style="list-style-type: none"> ▶ Spray both sides of cutting blades with STIHL resin solvent. ▶ If 3 LEDs continue to flash red: Do not use the hedge trimmer and contact your STIHL dealer for assistance. |
| | 3 LEDs light up red. | Hedge trimmer is too hot. | <ul style="list-style-type: none"> ▶ Remove the battery. ▶ Allow hedge trimmer to cool down. |
| | 4 LEDs flash red. | There is a fault in the battery. | <ul style="list-style-type: none"> ▶ Remove battery and reinsert it. ▶ Switch on the hedge trimmer. ▶ If 4 LEDs continue to flash red: Do not use the battery; contact a STIHL authorized dealer. |
| | | No electrical contact between hedge trimmer and battery. | <ul style="list-style-type: none"> ▶ Remove the battery. ▶ Clean electrical contacts in the battery compartment. ▶ Insert battery. |
| | | Hedge trimmer or battery is damp. | <ul style="list-style-type: none"> ▶ Allow gasoline extended hedge trimmer or battery to dry,  20.5. |
| Hedge trimmer cuts out during operation. | 3 LEDs light up red. | Hedge trimmer is too hot. | <ul style="list-style-type: none"> ▶ Remove the battery. ▶ Allow hedge trimmer to cool down. |
| | | There is an electrical fault. | <ul style="list-style-type: none"> ▶ Remove battery and reinsert it. ▶ Switch on the hedge trimmer. |
| Hedge trimmer runtime is too short. | | The battery is not fully charged. | <ul style="list-style-type: none"> ▶ Fully charge battery as described in the User Manual for the STIHL AL 101, 301, 301-4, 500 chargers. |
| | | The battery service life has been exceeded. | <ul style="list-style-type: none"> ▶ Replace battery. |
| STIHL connected app is unable to find the battery with  . | | Bluetooth® radio interface on the battery or mobile device is deactivated. | <ul style="list-style-type: none"> ▶ Activate Bluetooth® radio interface on the battery or mobile device. |
| | | Excessive distance between battery and mobile device. | <ul style="list-style-type: none"> ▶ Reduce distance,  20.3. ▶ If the battery still cannot be found with the STIHL connected app: Contact a STIHL authorized dealer for assistance. |

19.2 Product Support and Assistance on Use

Product support and assistance on use are available from STIHL servicing dealers.

For contacts and other information, please visit <https://support.stihl.com> or www.stihl.com.

20 Specifications

20.1 STIHL HLA 135, HLA 135 K long-reach hedge trimmer

HLA 135

– Permitted batteries:

- STIHL AP
- STIHL AR
- Weight without battery: 5.6 kg
- Degree of electrical protection: IPX4 (protection against splash water from any direction)

HLA 135 K

- Permitted batteries:
 - STIHL AP
 - STIHL AR
- Weight without battery: 5.2 kg
- Degree of electrical protection: IPX4 (protection against splash water from any direction)

The running time is shown at www.stihl.com/battery-life.

20.2 Cutting blades

HLA 135

- Tooth spacing: 34 mm
- Cutting length: 600 mm
- Sharpening angle: 45°

HLA 135 K

- Tooth spacing: 34 mm
- Cutting length: 600 mm
- Sharpening angle: 45°

20.3 STIHL AP battery

- Battery technology: lithium-ion
- Voltage: 36 V
- Capacity in Ah: see rating label
- Energy content in Wh: see rating label
- Weight in kg: see rating label
- Bluetooth® radio interface (only for batteries with ):
 - Data connection: Bluetooth® 5.1. The mobile appliance must be compatible with Bluetooth® Low Energy 5.0 and support Generic Access Profile (GAP).
 - Frequency band: ISM band 2.4 GHz
 - Maximum RF power transmitted: 1 mW
 - Signal range: approx. 10 m. The signal strength depends on the ambient conditions and the mobile terminal. Signal range can vary greatly depending on local conditions, including the receiver. The range may be perceptibly reduced inside enclosed rooms and through metal barriers (such as walls, shelves or cases).
 - Mobile appliance operating system requirements: Android or iOS (current version or higher)

20.4 Temperature limits



WARNING

- The battery is not protected against all ambient conditions. If the battery is exposed to certain environmental conditions, it may catch fire or explode. This may result in serious injury to people and damage to property.
 - ▶ Do not charge the battery below -20°C or above 50°C.
 - ▶ Do not use the battery or gasoline extended hedge trimmer below -20°C or above 50°C.
 - ▶ Do not store the battery or gasoline extended hedge trimmer below -20°C or above 50°C.

20.5 Recommended temperature ranges

For optimum performance of the battery and gasoline extended hedge trimmer, observe the following temperature ranges:

- Charging: 5°C to 40°C
- Use: - 10 °C to + 40 °C
- Storage: - 20 °C to + 50 °C

If the battery is charged, used or stored outside the recommended temperature ranges, performance may be restricted.

If the battery is wet or moist, allow the battery to dry for at least 48 h between 15°C and 50°C and with less than 70% humidity. Higher humidity may extend the drying time.

20.6 Sound Values and Vibration Values

The K-value for sound pressure levels is 2 dB(A).
K-value for sound power levels is 2 dB(A).
The K-value for vibration levels is 2 m/s².

HLA 135

- STIHL recommends wearing ear defenders.
- Sound pressure level L_{pA} measured according to ISO 22868: 85 dB(A)
 - Sound power level L_{wA} measured according to ISO 22868: 96 dB(A)
 - Vibration level a_{hv} measured according to ISO 22867, with handle hose
 - Control handle: 3.3 m/s²
 - Handle hose: 2.5 m/s²
 - Vibration level a_{hv} measured according to ISO 22867, with loop handle
 - Control handle: 2.5 m/s²
 - Loop handle: 3.7 m/s²

HLA 135 K

STIHL recommends wearing ear defenders.

- Sound pressure level L_{pA} measured according to ISO 22868: 85 dB(A)
- Sound power level L_{WA} measured according to ISO 22868: 96 dB(A)
- Vibration level a_{HV} measured according to ISO 22867
 - Control handle: 2.7 m/s²
 - Handle hose: 2.3 m/s²

The vibration levels indicated were measured according to a standardized test method and can be used as a basis for comparing electric power tools. The vibration levels actually occurring may vary from the values indicated, depending on the type of application. The vibration levels indicated can be used for an initial estimate of the vibration stress. The actual vibration stress has to be estimated. The times when the electric power tool is switched off and the times when it is switched on but running under no load can be taken into account in the estimate.

For information on compliance with Employers' Vibration Directive 2002/44/EC see www.stihl.com/vib.

20.7 REACH

REACH is an EC regulation and stands for the Registration, Evaluation, Authorisation and Restriction of Chemical substances.

For information on compliance with the REACH regulation see www.stihl.com/reach.

21 Combinations of Carrying Systems

21.1 Combinations of Carrying Systems

The long-reach hedge trimmer must be used only in combination with a carrying system. Approved carrying systems are listed in this User Manual:



Shoulder strap



Full harness



STIHL AR battery together with the support cushion



Battery belt with strap and attached "AP belt bag with connecting cable" together with the support cushion



Battery belt with attached "AP belt bag with connecting cable" together with the shoulder strap



Carrying system with built-in "AP belt bag with connecting cable" together with the support cushion



RTS backpack carrying system

22 Spare Parts and Accessories

22.1 Spare parts and accessories

STIHL These symbols indicate original STIHL spare parts and original STIHL accessories.

STIHL recommends the use of original STIHL spare parts and accessories.

Despite ongoing market observation, STIHL is unable to judge the reliability, safety and suitability of other manufacturers' spare parts and accessories; accordingly, STIHL cannot warrant for the use of those parts.

Original STIHL spare parts and original STIHL accessories are available from STIHL dealers.

23 Disposal

23.1 Disposing of the Hedge Trimmer and Battery

Contact the local authorities or your STIHL dealer for information on disposal.

Improper disposal can be harmful to health and pollute the environment.

- ▶ Take STIHL products including packaging to a suitable collection point for recycling in accordance with local regulations.
- ▶ Do not dispose with domestic waste.

24 EC Declaration of Conformity

24.1 STIHL HLA 135, HLA 135 K Gasoline extended Hedge Trimmer

ANDREAS STIHL AG & Co. KG
Badstraße 115
D-71336 Waiblingen
Germany

declare under our sole responsibility that

- Category: Cordless long-reach hedge trimmer
- Manufacturer's brand: STIHL
- Model: HLA 135, HLA 135 K
- Serial identification: HA04

conforms to the relevant provisions of Directives 2011/65/EU, 2006/42/EC, 2014/30/EU and 2000/14/EC and has been developed and manufactured in compliance with the following standards in the versions valid on the date of production: EN 55014-1, EN 55014-2, EN 62841-1 and EN 62841-4-2.

Applied conformity assessment procedure in accordance with Directive 2000/14/EC, Annex V.

- Measured sound power level: 96 dB(A)
- Guaranteed sound power level: 98 dB(A)

The technical documents are stored at ANDREAS STIHL AG & Co. KG Produktzulassung.

The year of manufacture, country of manufacture and serial number are shown on the long-reach hedge trimmer.

Waiblingen, 2022-08-01

ANDREAS STIHL AG & Co. KG

pp 

Robert Olma, Vice President, Regulatory Affairs & Global Governmental Relations

25 UKCA Declaration of Conformity

25.1 STIHL HLA 135, HLA 135 K Gasoline extended Hedge Trimmer

**UK
CA**

ANDREAS STIHL AG & Co. KG
Badstraße 115
D-71336 Waiblingen

Germany

declare under our sole responsibility that

- Category: Cordless long-reach hedge trimmer
- Manufacturer's brand: STIHL
- Model: HLA 135, HLA 135 K
- Serial identification: HA04

conforms to the relevant provisions of UK regulations The Restriction of the Use of Certain Hazardous Substances in Electrical and Electronic Equipment Regulations 2012, Supply of Machinery (Safety) Regulations 2008, Electromagnetic Compatibility Regulations 2016 and Noise Emission in the Environment by Equipment for use Outdoors Regulations 2001 and has been manufactured in compliance with the following standards in the versions valid on the date of production: EN 55014-1, EN 55014-2, EN 62841-1, and EN 62841-4-2.

Applied conformity assessment procedure in accordance with UK regulations Noise Emission in the Environment by Equipment for use Outdoors Regulations 2001 Schedule 8.

- Measured sound power level: 96 dB(A)
- Guaranteed sound power level: 98 dB(A)

The technical documents are stored at ANDREAS STIHL AG & Co. KG.

The year of manufacture, country of manufacture and serial number are shown on the long-reach hedge trimmer.

Waiblingen, 2022-08-01

ANDREAS STIHL AG & Co. KG

pp 

Robert Olma, Vice President, Regulatory Affairs & Global Governmental Relations

26 General Power Tool Safety Warnings

26.1 Introduction

This chapter reproduces the pre-formulated, general safety precautions specified in the IEC 62841 standard for hand-held motor-operated electric tools.

STIHL is obliged to publish these texts.

The safety precautions and warnings on avoiding an electric shock given under "Electrical Safety" do not apply to STIHL cordless products.

WARNING

- **Read all safety warnings, instructions, illustrations and specifications provided with this power tool.** Failure to follow all instructions listed below may result in electric shock, fire and/or serious injury. **Save all warnings and instructions for future reference.**

The term "electric power tool" in the safety warnings refers to mains-operated (corded) power tools or battery-operated (cordless) power tools.

26.2 Work area safety

- a) **Keep work area clean and well lit.** Cluttered or dark areas invite accidents.
- b) **Do not operate power tools in explosive atmospheres, such as in the presence of flammable liquids, gases or dust.** Power tools create sparks which may ignite the dust or fumes.
- c) **Keep children and bystanders away while operating a power tool.** Distractions can cause you to lose control.

26.3 Electrical safety

- a) **Power tool plugs must match the outlet. Never modify the plug in any way. Do not use any adapter plugs with earthed (grounded) power tools.** Unmodified plugs and matching outlets will reduce risk of electric shock.
- b) **Avoid body contact with earthed or grounded surfaces, such as pipes, radiators, ranges and refrigerators.** There is an increased risk of electric shock if your body is earthed or grounded.
- c) **Do not expose power tools to rain or wet conditions.** Water entering a power tool will increase the risk of electric shock.

- d) **Do not abuse the cord. Never use the cord for carrying, pulling or unplugging the power tool. Keep cord away from heat, oil, sharp edges or moving parts.** Damaged or entangled cords increase the risk of electric shock.
- e) **When operating a power tool outdoors, use an extension cord suitable for outdoor use.** Use of a cord suitable for outdoor use reduces the risk of electric shock.
- f) **If operating a power tool in a damp location is unavoidable, use a residual current device (RCD) protected supply.** Use of an RCD reduces the risk of electric shock.

26.4 Personal safety

- a) **Stay alert, watch what you are doing and use common sense when operating a power tool. Do not use a power tool while you are tired or under the influence of drugs, alcohol or medication.** A moment of inattention while operating power tools may result in serious personal injury.
- b) **Use personal protective equipment. Always wear eye protection.** Protective equipment such as a dust mask, non-skid safety shoes, hard hat or hearing protection used for appropriate conditions will reduce personal injuries.
- c) **Prevent unintentional starting. Ensure the switch is in the off-position before connecting to power source and/or battery pack, picking up or carrying the tool.** Carrying power tools with your finger on the switch or energising power tools that have the switch on invites accidents.
- d) **Remove any adjusting key or wrench before turning the power tool on.** A wrench or a key left attached to a rotating part of the power tool may result in personal injury.
- e) **Do not overreach. Keep proper footing and balance at all times.** This enables better control of the power tool in unexpected situations.
- f) **Dress properly. Do not wear loose clothing or jewellery. Keep your hair and clothing away from moving parts.** Loose clothes, jewellery or long hair can be caught in moving parts.
- g) **If devices are provided for the connection of dust extraction and collection facilities, ensure these are connected and properly used.** Use of dust collection can reduce dust-related hazards.

- h) **Do not let familiarity gained from frequent use of tools allow you to become complacent and ignore tool safety principles.** A careless action can cause severe injury within a fraction of a second.

26.5 Power tool use and care

- a) **Do not force the power tool. Use the correct power tool for your application.** The correct power tool will do the job better and safer at the rate for which it was designed.
- b) **Do not use the power tool if the switch does not turn it on and off.** Any power tool that cannot be controlled with the switch is dangerous and must be repaired.
- c) **Disconnect the plug from the power source and/or remove the battery pack, if detachable, from the power tool before making any adjustments, changing accessories, or storing power tools.** Such preventive safety measures reduce the risk of starting the power tool accidentally.
- d) **Store idle power tools out of the reach of children and do not allow persons unfamiliar with the power tool or these instructions to operate the power tool.** Power tools are dangerous in the hands of untrained users.
- e) **Maintain power tools and accessories. Check for misalignment or binding of moving parts, breakage of parts and any other condition that may affect the power tool's operation. If damaged, have the power tool repaired before use.** Many accidents are caused by poorly maintained power tools.
- f) **Keep cutting tools sharp and clean.** Properly maintained cutting tools with sharp cutting edges are less likely to bind and are easier to control.
- g) **Use the power tool, accessories and tool bits etc. in accordance with these instructions, taking into account the working conditions and the work to be performed.** Use of the power tool for operations different from those intended could result in a hazardous situation.
- h) **Keep handles and grasping surfaces dry, clean and free from oil and grease.** Slippery handles and grasping surfaces do not allow for safe handling and control of the tool in unexpected situations.

26.6 Battery tool use and care

- a) **Recharge only with the charger specified by the manufacturer.** A charger that is suitable for one type of battery pack may create a risk of fire when used with another battery pack.
- b) **Use power tools only with specifically designed battery packs.** Use of any other battery packs may create a risk of injury and fire.
- c) **When battery pack is not in use, keep it away from other metal objects, like paper clips, coins, keys, nails, screws or other small metal objects, that can make a connection from one terminal to another.** Shorting the battery terminals together may cause burns or a fire.
- d) **Under abusive conditions, liquid may be ejected from the battery; avoid contact. If contact accidentally occurs, flush with water. If liquid contacts eyes, additionally seek medical help.** Liquid ejected from the battery may cause irritation or burns.
- e) **Do not use a battery pack or tool that is damaged or modified.** Damaged or modified batteries may exhibit unpredictable behaviour resulting in fire, explosion or risk of injury.
- f) **Do not expose a battery pack or tool to fire or excessive temperature.** Exposure to fire or temperature above 130 °C may cause explosion.
- g) **Follow all charging instructions and do not charge the battery pack or tool outside the temperature range specified in the instructions.** Charging improperly or at temperatures outside the specified range may damage the battery and increase the risk of fire.

26.7 Service

- a) **Have your power tool serviced by a qualified repair person using only identical replacement parts.** This will ensure that the safety of the power tool is maintained.
- b) **Never service damaged battery packs.** Service of battery packs should only be performed by the manufacturer or authorized service providers.

26.8 Hedge trimmer safety warnings

Safety instructions for hedge trimmers

- a) **Keep all parts of the body away from the blade. Do not remove cut material or hold material to be cut when blades are moving.** Blades continue to move after the switch is

- turned off. A moment of inattention while operating the hedge trimmer may result in serious personal injury.
- b) **Carry the hedge trimmer by the handle with the blade stopped and taking care not to operate any power switch.** Proper carrying of the hedge trimmer will decrease the risk of inadvertent starting and resultant personal injury from the blades.
 - c) **When transporting or storing the hedge trimmer, always fit the blade cover.** Proper handling of the hedge trimmer will decrease the risk of personal injury from the blades.
 - d) **When clearing jammed material or servicing the unit, make sure all power switches are off and the power cord is disconnected.** Unexpected actuation of the hedge trimmer while clearing jammed material or servicing may result in serious personal injury.
 - e) **Hold the hedge trimmer by insulated gripping surfaces only, because the blade may contact hidden wiring or its own cord.** Blades contacting a "live" wire may make exposed metal parts of the hedge trimmer "live" and could give the operator an electric shock.
 - f) **Keep all power cords and cables away from cutting area.** Power cords or cables may be hidden in hedges or bushes and can be accidentally cut by the blade.
 - g) **Do not use the hedge trimmer in bad weather conditions, especially when there is a risk of lightning.** This decreases the risk of being struck by lightning.

26.9 Additional safety instructions for extended-reach hedge trimmers

Extended-reach hedge trimmer safety warnings

- a) **To reduce the risk of electrocution, never use the extended-reach hedge trimmer near any electrical power lines.** Contact with or use near power lines may cause serious injury or electric shock resulting in death.
- b) **Always use two hands when operating the extended-reach hedge trimmer.** Hold the extended-reach hedge trimmer with both hands to avoid loss of control.
- c) **Always use head protection when operating the extended-reach hedge trimmer overhead.** Falling debris can result in serious personal injuries.

www.stihl.com



0458-683-0121-C



0458-683-0121-C